

PIETBOON.collection

Instructions DOUTZEN sofa

Congratulations with your purchase.

Every product from the Piet Boon Collection is clearly recognisable by its sober, sturdy style and the use of natural and honest materials. Comfort, durability and a timeless design are the conditions which we place on each product. Our furniture is consciously finished in such a manner that in daily use it gains even more character. We hope you have a great deal of pleasure from your purchase.

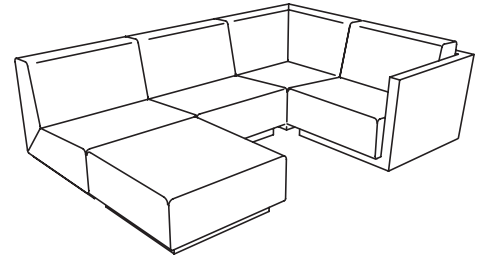

Product specifications

material Frame: metal with elastic webbing, upholstered with shape retaining foam. Seat cushions: shape retaining foam and a toplayer of dacron.

	DOUTZEN sofa	
dimensions (dxwxh)	corner l/r 95	95x95x80 cm
	arm l/r 95	95x95x80 cm
	arm l/r 130	95x130x80 cm
	back 85	95x85x80 cm
	back 120	95x120x80 cm

Piet Boon Collection reserves all rights for changes to the model
More product informatie can be found at www.pietboon.com

Maintenance general

Do not place the product in direct sunlight as this can cause the fabric to discolor. It is recommended to regularly fluff loose cushions up. This prevents creases forming in the cushions.

Cleaning fabrics

We strongly advise not to dab and scrub soiled spots. This can cause permanent damage to the structure of the upholstery material. For the various kinds of stains refer to a specialized cleaning company. The cleaning should only be carried out by a specialized cleaning company with the explicit statement: "Dry cleaning only"

Maintenance fabrics

If you vacuum clean your furniture once a month you will avoid the accumulation of dirt in the furniture and that small particles, such as sand, cause wear to the upholstery material. Vacuum carefully and always in the direction of the nap of the fabric.

Cleaning lacquered leather cat. D

Dirt can be removed from the leather with a soft damp clean cloth, with possibly some alkali soap. Do this with a rotating movement.

Maintenance lacquered leather cat. D

The leather needs almost no maintenance. Nevertheless we recommend to treat the leather with leather protector once a year.

Cleaning stonewash leather cat. S

This is the most natural leather in the Piet Boon® Collection for the real connoisseur. After tanning the leather it has just been given a thin protective finish. This gives the leather its unique character, but also makes it a sensitive type of leather. Over time this leather will get its unique weathered character. Cleaning of this semi-aniline leather can be done with special maintenance products, intended for this purpose. Dirt can be removed from the leather with a soft damp clean cloth or leather cleaner, but avoid hard scrubbing. Use a minimum of water or detergent to prevent stains. Test first on an inconspicuous area.

Maintenance stonewash leather cat. S

To prevent dehydration we recommend to treat the leather with leather protector twice a year.

Cleaning nubuck leather cat. N

Moisture, dirt and oils result in permanent stains because of its open structure. These stains can be sanded with a very fine sandpaper or suede brush. Remove stains with a soft clean cloth and leather cleaner, avoiding hard scrubbing. When after patting the stain, there is still a dark spot, you can assume it will slowly fade during time. Never use chemicals and detergents. Protection and cleaning of nubuck leather can be done with special maintenance products, intended for leather with an open structure. Test first on an inconspicuous area.

Maintenance nubuck leather cat. N

We recommend to treat the nubuck once per year with a nubuck protector spray to prevent penetration of stains and moisture.

Guarantee

See general terms & conditions.

Instructions **DOUTZEN sofa**

1. Before attaching the elements together. Choose your desired assembly.

On the illustration at the right you see one of the many possible assemblies of the DOUTZEN.

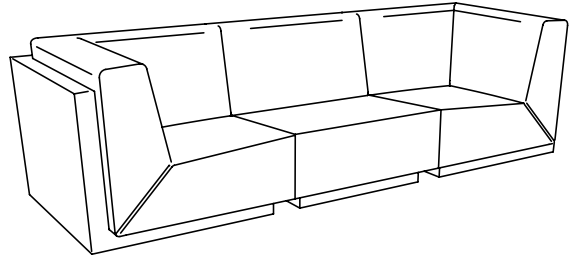

2. Place the clip under the sofa element.

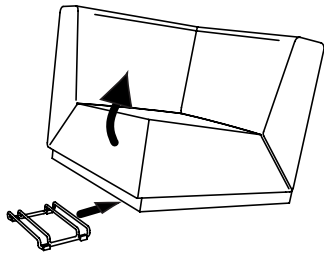

3. Slide the clip from the front to the back until it falls between the caps.

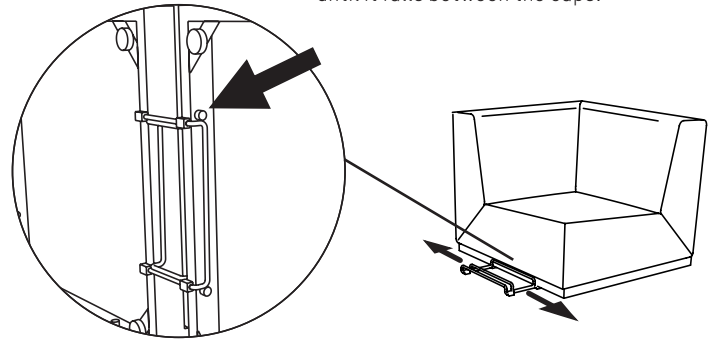

4. Place the next sofa element over the clip.

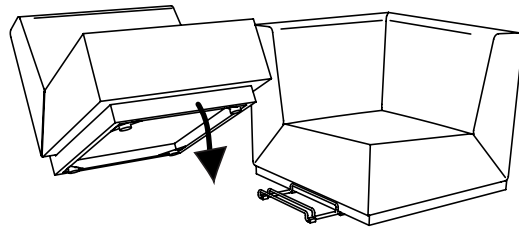

5. Slide the sofa element from the front to the back until the clip falls between the caps.

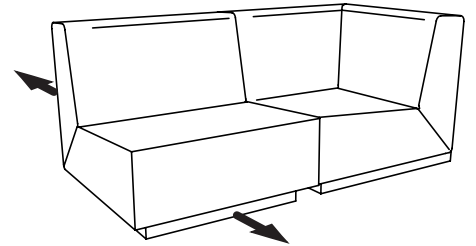

6. Place the next clip under the sofa element in the same way.

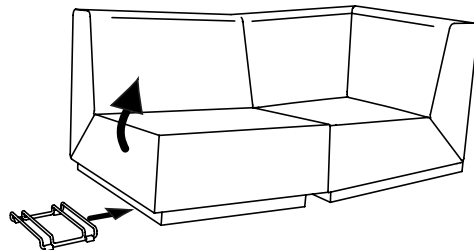

7. After which you place the last element over the clip.

